

Chempump

# G Series



Canned Motor Pumps

## Exceptional Fugitive Emissions Containment

Chempump introduced the first hermetically sealed pump and motor design over 50 years ago, and we've been improving it ever since. That's why "Specify Chempump" has become an industry standard for sealless canned motor pumps.

The G SERIES centrifugal pump is designed as a **single sealless unit** that has no stuffing box, no seals, no packing. **Pumped fluids cannot leak out** or be contaminated by in-leakage. No special tools, foundation, leveling or alignment are required for installation.

Choose from **more than 100 models** in 30 sizes from 1 to 125 HP, capacities to 2,000 GPM and fluid temperatures of -400°F to +1,000°F.

## Standard Features

### *Automatic Thrust Balance*

An automatic thrust balance feature equalizes hydraulic pressures across the rotor and impeller, thereby eliminating axial thrust.

### *Precision Front and Rear Bearings*

Manufactured to extremely close tolerances, Chempump bearings ensure longer life and maintenance-free operation. Bearings can be supplied in materials to suit virtually any pumped fluid.

### *Oil-Filled Stator Cavity*

The stator winding cavity can be filled with a dielectric oil, to greatly improve the rate of heat dissipation from the motor windings and to protect against condensation damage. This, combined with a high grade of insulation, results in a motor life expectancy that exceeds NEMA standards by a wide margin.

### *Built-In Thermal Cut-Out*

Motors are protected against excessive heat by a built-in thermal cut-out, which must be wired into the electrical power-source. If the motor windings reach a pre-set temperature limit, the pump will automatically shut down before permanent damage can occur.

### *Direction of Rotation Indicator*

The direction of rotation indicator is a compact addition to the electrical junction box that illuminates to verify correct direction of rotation.

### *Replaceable Thrust Surfaces*

All G SERIES pumps are fitted with easily replaceable thrust surfaces to prevent damage from axial thrust during system upsets.

*Automatic Thrust Balance*



*Rotation Indicator*

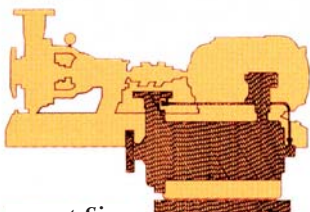

*Compact Size*

# Chempump Canned Motor Pumps

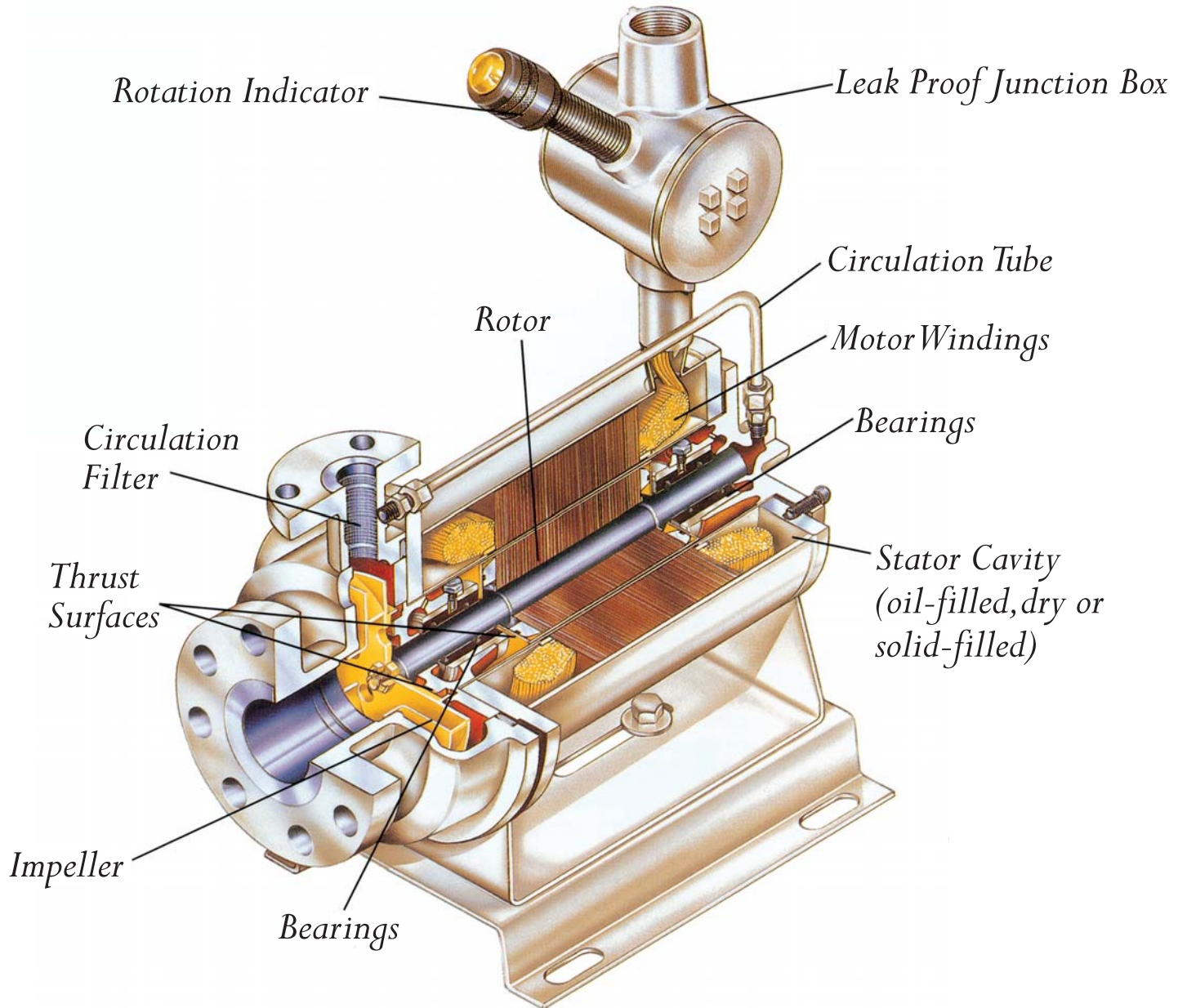

## Operation

The G SERIES pump has only one moving part – a combined rotor and impeller assembly that is driven by an induction motor.

A small portion of the pumped fluid is allowed to circulate through the motor section, cooling the motor and lubricating and cooling the bearings. The circulating fluid passes through a self-cleaning filter (fitted in the discharge neck of the pump casing) through the circulation tube to the rear of the pump. It then flows into the rotor cavity (where it is isolated from the motor windings by a corrosion resistant, non-magnetic alloy liner), across the bearings, and back into the main flow.

The discharge filter contributes to extended motor and bearing life by keeping the circulating fluid free of damaging particles. This filter is self-cleaning because it is open at the top and bottom and is constantly washed by the discharge flow.

# G SERIES PUMPS

## 1-5 HP Models for Fluid Temperatures up to 400°F

An industry standard for low HP applications, Chempump's GA, GB, GC and GVBS models provide single-stage pumping at heads up to 180 feet. The G SERIES design is also available as a regenerative turbine pump designed for high-head, low-flow applications.



SINGLE-STAGE

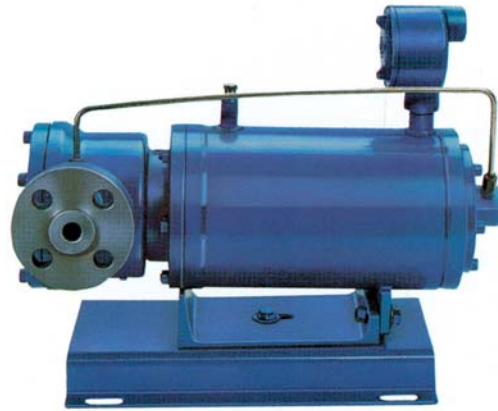

REGENERATIVE

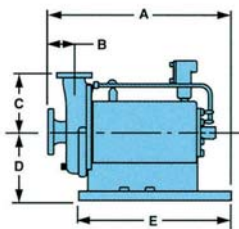
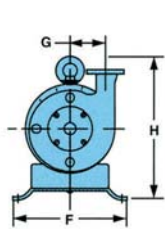

SINGLE-STAGE

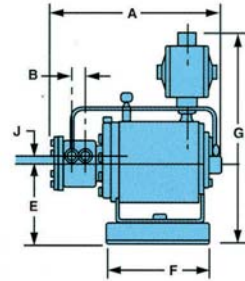
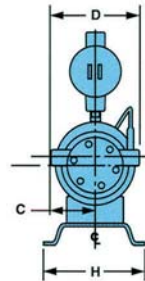

MODEL W2B REGENERATIVE

### SPECIFICATIONS

	MOTOR SPEED (RPM)	MODEL DESIG.	MOTOR SIZES (HP)	SUCT. (in.)	DISCH. (in.)	IMPELLER (Max. dia., in.)	DIMENSIONS (in.) <sup>1</sup>							
							A	B	C	D	E	F	G	H
SINGLE STAGE	3450 or 1750	GA	1	1	3/4	5	13 <sup>9</sup> / <sub>8</sub>	2 <sup>1</sup> / <sub>2</sub>	6	7 <sup>3</sup> / <sub>16</sub>	9 <sup>1</sup> / <sub>2</sub>	8 <sup>1</sup> / <sub>2</sub>	2 <sup>9</sup> / <sub>16</sub>	15 <sup>15</sup> / <sub>16</sub>
		GB	1, 1 <sup>1</sup> / <sub>2</sub>	1	3/4	6 <sup>1</sup> / <sub>2</sub>	16 <sup>11</sup> / <sub>16</sub>	3	6 <sup>3</sup> / <sub>4</sub>	7 <sup>1</sup> / <sub>16</sub>	12 <sup>1</sup> / <sub>4</sub>	8 <sup>1</sup> / <sub>2</sub>	3 <sup>1</sup> / <sub>8</sub>	15 <sup>15</sup> / <sub>16</sub>
		GC	3, 5	2	1 <sup>1</sup> / <sub>2</sub>	5	17	2 <sup>1</sup> / <sub>8</sub>	6 <sup>3</sup> / <sub>8</sub>	7 <sup>1</sup> / <sub>16</sub>	12 <sup>1</sup> / <sub>4</sub>	8 <sup>1</sup> / <sub>2</sub>	2 <sup>9</sup> / <sub>16</sub>	15 <sup>15</sup> / <sub>16</sub>
		GVBS		3	1 <sup>1</sup> / <sub>2</sub>	6	18 <sup>3</sup> / <sub>8</sub>	4	6 <sup>1</sup> / <sub>2</sub>	7 <sup>1</sup> / <sub>16</sub>	12 <sup>1</sup> / <sub>4</sub>	8 <sup>1</sup> / <sub>2</sub>	CL <sup>2</sup>	12 <sup>15</sup> / <sub>16</sub>

### REGENERATIVE MODEL SPECIFICATIONS

	MOTOR SPEED (RPM)	MODEL DESIG.	MOTOR SIZES (nom. HP)	SUCT. (in.)	DISCH. (in.)	DIMENSIONS (in.) <sup>1</sup>							
						A	B	C	D	E	F	G	H
3450	W2B	1, 1 <sup>1</sup> / <sub>2</sub>	1/2	1/2	15 <sup>1</sup> / <sub>16</sub>	1 <sup>1</sup> / <sub>8</sub>	3 <sup>1</sup> / <sub>4</sub>	6 <sup>1</sup> / <sub>2</sub>	7 <sup>3</sup> / <sub>16</sub>	9 <sup>1</sup> / <sub>2</sub>	18 <sup>13</sup> / <sub>16</sub>	8 <sup>1</sup> / <sub>2</sub>	7 <sup>1</sup> / <sub>16</sub>
	W2C	3, 5	1	3/4	19 <sup>9</sup> / <sub>16</sub>	1 <sup>1</sup> / <sub>8</sub>	5 <sup>7</sup> / <sub>16</sub>	10 <sup>7</sup> / <sub>8</sub>	7 <sup>1</sup> / <sub>4</sub>	13 <sup>3</sup> / <sub>8</sub>	22 <sup>1</sup> / <sub>16</sub>	8 <sup>1</sup> / <sub>2</sub>	3 <sup>1</sup> / <sub>4</sub>

1. Approximate dimensions based on largest motor size available for model.  
2. CL denotes centerline discharge.

# 5-125 HP Models for Fluid Temperatures up to 400°F

G SERIES pumps are available in single-stage, end-suction and two-stage designs built specifically for pumping at heads up to 700 feet. In the two-stage design, axial thrust is balanced by identical opposing impellers and radial thrust by opposing discharge flows.

## SPECIFICATIONS

	MOTOR SPEED (RPM)	MODEL DESIG.	MOTOR SIZES (HP)	SUCT. (in.)	DISCH. (in.)	IMPELLER (Max. dia., in.)	DIMENSIONS (in.) <sup>1</sup>							
							A	B	C	D	E	F	G	H
SINGLE STAGE	3450 or 1750	GVD		3	1½	8	27	4	8½	8¼	25	11½	CL <sup>2</sup>	18 <sup>9</sup> / <sub>16</sub>
		GVE	5,7½,10,	3	2	8	26½	4 <sup>1</sup> / <sub>16</sub>	9 <sup>1</sup> / <sub>16</sub>	6¾	23	11 <sup>5</sup> / <sub>8</sub>	CL <sup>2</sup>	16 <sup>1</sup> / <sub>16</sub>
		GVHS	15, 20	2	1	9½	27½	4	8½	8¼	25	13¾	CL <sup>2</sup>	18 <sup>7</sup> / <sub>8</sub>
		GG		4	3	7	31 <sup>3</sup> / <sub>16</sub>	5	8½	9	25	14¾	5	19 <sup>1</sup> / <sub>8</sub>
		GK	40,50,60	4	3	8 <sup>7</sup> / <sub>8</sub>	34¼	5 <sup>7</sup> / <sub>8</sub>	9 <sup>9</sup> / <sub>16</sub>	11¾	25	18	6 <sup>9</sup> / <sub>8</sub>	25
	GKS		3	2	10	32½	4¾	9	11¾	25	18	15 <sup>7</sup> / <sub>32</sub>	25	
	1750 or 1150	GVM	3,5,7½,10,15	4	3	9	26 <sup>7</sup> / <sub>8</sub>	5 <sup>1</sup> / <sub>16</sub>	8 <sup>3</sup> / <sub>16</sub>	9	20	14¾	CL <sup>2</sup>	19¾
		GP	15,20,25,30	6	4	11	32½	6¾	10½	11½	24	18	9	22
		GN	25, 30	4	3	15½	55 <sup>5</sup> / <sub>8</sub>	9 <sup>1</sup> / <sub>8</sub>	22	17	44½	20	CL <sup>2</sup>	39
		GPS	40, 50, 60	6	4	15½	55 <sup>5</sup> / <sub>8</sub>	9 <sup>1</sup> / <sub>8</sub>	22	17	44½	20	CL <sup>2</sup>	39
GRS		75, 100, 125	8	6	15½	55 <sup>5</sup> / <sub>8</sub>	9 <sup>1</sup> / <sub>8</sub>	22	17	44½	20	CL <sup>2</sup>	39	
TWO STAGE	3450	N2S	20, 30, 40, 50	3	1½	9 <sup>1</sup> / <sub>8</sub>	39½	0	8½	13½	30	12	CL <sup>2</sup>	27

1. Approximate dimensions based on largest motor size available for model.
2. CL denotes centerline discharge.

## Special Application Engineering

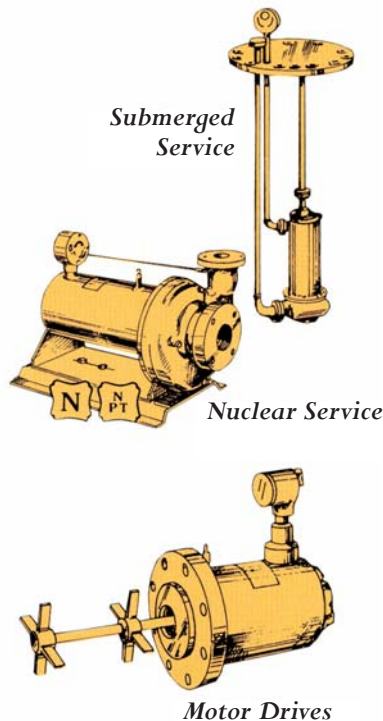

### Submerged Service Pumps

G SERIES submerged service pumps offer many advantages over conventional pumps when used in sumps in the nuclear and chemical processing industries. Modification for submerged service is simple and economical.

### Nuclear Service Pumps

Chempump's experience in nuclear service pumps dates back to the early 1950's. G SERIES nuclear service pumps can be provided with the A.S.M.E. "N" stamp, Class 1, 2, and 3, and are qualified for IEEE 323 service. Seismic qualification is available to meet all requirements for nuclear energy applications.

### Slurry Service

For fluids with suspended solids, G SERIES slurry service pumps feature

a closure seal design that prevents process fluid (which contains solid particles) from entering the motor section. As an alternative method, Chempump offers an external circulation line filter for effective handling of fluid containing suspended solids.

### Lethal Fluid Service

Chempump can provide pumps built to paragraph UW-2 of section VIII of the A.S.M.E. code. Custom-designed pumps are also available.

### Canned Motor Drives

G SERIES canned motor drives are used principally in agitators, mixers and similar applications that require a sealless motor. The rotor shaft is extended beyond the motor section to accommodate agitator blades.

# HIGH-TEMPERATURE PUMPS

## 1-125 HP Models for Fluid Temperatures up to 1000°F

GT and GH SERIES pumps are ideally suited for sealless handling of high-temperature fluids. Model GT requires cooling water. Model GH operates at temperatures up to 650°F without cooling water.



GT SERIES



GH SERIES

### SPECIFICATIONS

MOTOR SPEED (RPM)	MODEL DESIG.	MOTOR SIZES (HP)	SUCT. (in.)	DISCH. (in.)	DIMENSIONS (in.) <sup>*</sup>					
					A	B	C	D	E	F
3450 or 1750 RPM	GAT		1	3/4	6	2 1/2	2 5/16	18	14 3/8	7 13/16
	GBT	1, 1 1/2	1	3/4	6 3/4	3	3 3/8	19 11/16	16 1/8	7 3/16
	GCT	3, 5	2	1 1/2	6 5/8	2 7/8	2 5/16	19 3/16	16 1/8	7 3/16
	GVBST		3	1 1/2	6 1/2	4	CL <sup>2</sup>	22 13/16	17 7/8	7 3/16
	GVDT		3	1 1/2	8 1/2	4	CL <sup>2</sup>	33 7/8	25	8 1/4
	GVET	5, 7 1/2	3	2	9 1/2	4	CL <sup>2</sup>	27 1/2	23	8 1/4
	GVHST	10, 15, 20	2	1	8 1/2	4	CL <sup>2</sup>	38 3/4	25	8 1/4
	GGT		4	3	8 1/2	5	5	30 7/8	25	9
1750 or 1150 RPM	GKT	40, 50, 60	4	3	9 1/16	5 7/8	6 5/8	34 1/4	25	11 3/4
	GKST		3	2	9	4 3/4	5 17/32	32 1/2	25	11 3/4
	GNT	7 1/2, 10, 15, 25, 30, 40, 50	4	3	22	9 3/8	CL <sup>2</sup>	55 3/8	44 1/2	17
	GVMT	3, 5, 7 1/2, 10, 15	4	3	11 11/16	5 1/16	CL <sup>2</sup>	26 3/8	20	9 3/4
	GPT	15, 20, 25, 30	6	4	10 1/2	6 3/16	7 1/2	32 1/2	24	13 1/16
1750 or 1150 RPM	GPST	25, 30, 40, 50, 60	6	4	22	9 3/8	CL <sup>2</sup>	55 3/8	44 1/2	17
	GRST	75, 100, 125	8	6	22	9 3/8	CL <sup>2</sup>	55 3/8	44 1/2	17

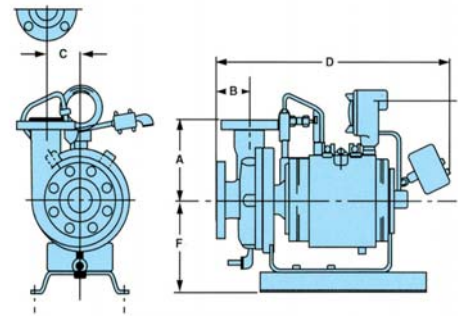

GT SERIES

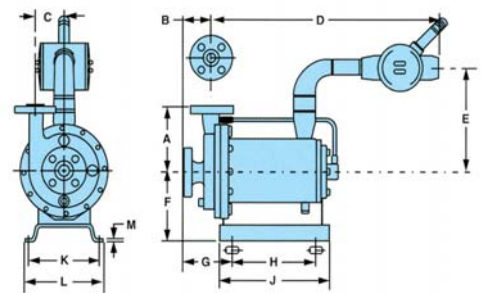

GH SERIES

MODEL	MOTOR SIZES (HP)	SUCT. (in.)	DISCH. (in.)	DIMENSIONS (in.) <sup>1</sup>											
				A	B	C	D	E	F	G	H	J	K	L	M
GAH	3	1	3/4	6	2 1/2	2 5/16	26 3/8	10 3/4	7 3/16	5 3/8	9 1/4	12 1/4	7 1/2	8 1/2	3 1/16
GBH		1	3/4	6 3/4	3	3 3/8	26 5/16	10 3/4	7 3/16	5 7/16	9 1/4	12 1/4	7 1/2	8 1/2	3 1/16
GCH		2	1 1/2	6 3/8	2 7/8	2 9/16	26 9/16	10 3/4	7 3/16	5 3/4	9 1/4	12 1/4	7 1/2	8 1/2	3 1/16
GVBSH		3	1 1/2	6 1/2	4	CL <sup>2</sup>	27	10 3/4	7 3/16	7 1/8	9 1/4	12 1/4	7 1/2	8 1/2	3 1/16
GVDH	10	3	1 1/2	8 1/2	4	CL <sup>2</sup>	34 1/2	11 1/2	8 1/4	4	12 1/2	25	9 3/4	11 1/4	1/4
GVEH		3	2	9 1/2	4	CL <sup>2</sup>	34 1/2	11 1/2	8 1/4	4	12 1/2	25	9 3/4	11 1/4	1/4
GVHSH		2	1	8 1/2	4	CL <sup>2</sup>	34 1/2	11 1/2	8 1/4	4	12 1/2	25	9 3/4	11 1/4	1/4

1. Approximate dimensions based on largest motor size available for model.  
2. CL denotes centerline discharge.

# G SERIES OPTIONAL FEATURES

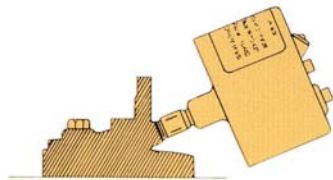

*Bearing Wear Detector*

## ***Bearing Wear Detector***

- Inexpensive addition to new pumps or simple retrofit to existing units
- Indicates when bearings require replacement
- Helps prevent system downtime caused by pump malfunction
- Adaptable for remote control operation
- U.L. listed

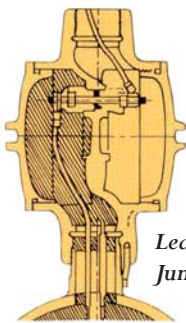

*Leakproof Junction Box*

## ***Leakproof Junction Box***

- Designed to prevent system fluid from leaking into the electrical conduit line in the event of a malfunction
- U.L. listed
- Simple retrofit to existing pumps

## ***Hardened Rotor Journals***

- Corrosion-resistant, wear-resistant
- Can extend useful life to many times that of other journals

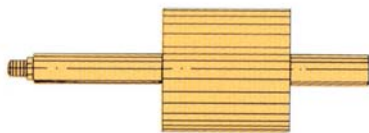

*Hardened Rotor Journals*

## ***Pressurized Circulation System***

- Self-contained
- Improves pump's ability to handle liquids at or near their boiling (vapor pressure) points
- Handles such liquids as ammonia, refrigerants, fluorocarbons and chlorinated hydrocarbons

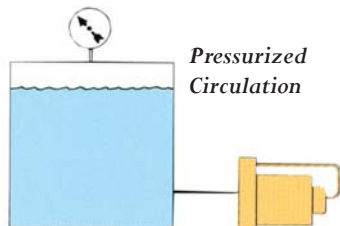

*Pressurized Circulation*

## ***Inducers***

- Developed to improve required net positive suction head (NPSH)
- Installs easily to simplify field retrofit
- Simple retrofit to existing pumps

## ***Back Flush***

- Used where solids are present in the pumped fluid or where fluid viscosities are high
- Prevents solid particles from reaching the bearings

## ***UL-Listed Explosion-Proof Design***

- Meets UL requirements for explosion-proof operation
- Can be furnished with Class 1, Group D, Div. 1 or Class 1, Groups C and D, Div. 1 certification

## ***High-Temperature Motor Insulation***

- Chempump uses motor insulation capable of withstanding fluid temperatures of up to 650°F without cooling jackets or heat exchangers. This feature can be provided for any G SERIES pump
- GT SERIES models can be retrofitted with high-temperature insulation to eliminate cooling water requirements

## ***Dry/Solid Filled Motor***

- All Chempump motors are capable of operating without oil in the stator cavity
- Used where system contamination control or absolute secondary containment is critical

## ***Temperature Sensors***

- Highly sensitive temperature monitoring of fluid in the rotor cavity
- Provides shutdown in the event of abnormal temperature rise
- Can be used with any temperature indication device

## ***Heat Exchangers***

- For applications that require heating or cooling of fluids before the fluid enters the rotor chamber
- Simple retrofit to existing pumps

## ***Water Jackets***

- Provide additional motor cooling or heating when handling fluids at controlled temperatures
- Simple retrofit to existing pumps

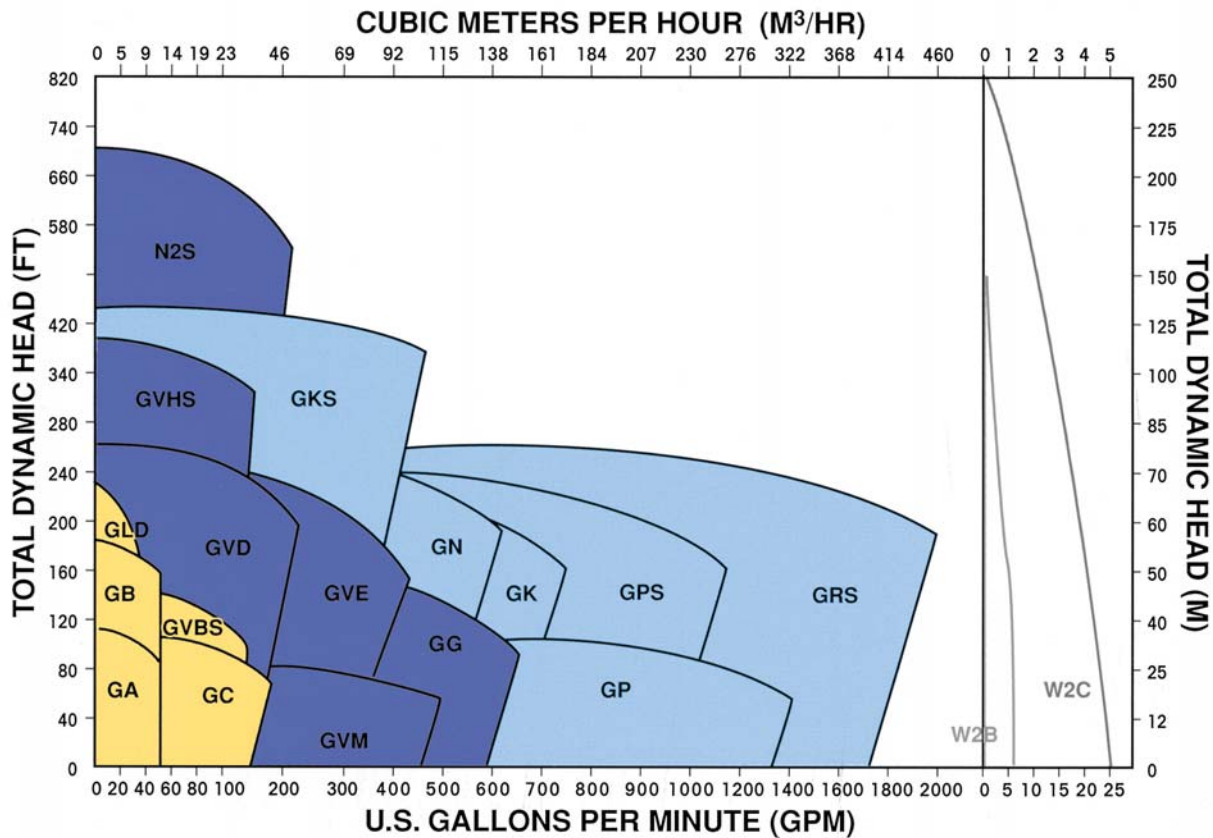

## Hydraulic Coverage

The composite performance curve above gives approximate flow rates and total dynamic heads for G SERIES\* models, based on

20°C water at sea level. Individual, detailed performance curves are available on our website: [www.chempump.com](http://www.chempump.com).

\*Also applicable to GT and GH SERIES pumps.

## Support Services

Chempump gives you much more than the most reliable pumps available. We offer an unprecedented record of application and engineering experience, and a commitment to providing the best aftermarket service in the business.

Our regular pump seminars and training programs ensure that you get the greatest value out of your pumps. Our factory service centers are strategically located throughout the country for fast turnaround of your service requests.

### *Materials*

Steel, 316 Stainless Steel and Carpenter 20 are standard materials of construction. Also available are Monel, Hastelloy B or C, and other materials, as needed.

### *2-Year Warranty*

Based on an unprecedented application history of over 50 years, Chempump offers a 2-year warranty.



**Teikoku USA:** 7010 Empire Central Drive, Houston, TX 77040-3214 Phone: (713) 983-9901 Fax: (713) 983-9919 Website: [www.teikoku-usa.com](http://www.teikoku-usa.com) E-mail: [info@teikoku-usa.com](mailto:info@teikoku-usa.com)

**Chempump:** 959 Mearns Road, Warminster, PA 18974 Phone: (215) 343-6000 Fax: (267) 486-1037 Website: [www.chempump.com](http://www.chempump.com) E-mail: [chempump@chempump.com](mailto:chempump@chempump.com)

**Midwest Service Center:** State Route 2 North, Belmont, WV 26134 Phone: (304) 684-2459 Fax: (304) 684-7593

Bulletin G Series Rev.6 Printed in the USA 04/07